

CLIMAGUARD™ AIR-TO-AIR INDOOR

XR20 Models 4 W/°F (7 W/°C)	XR29-08 Models 8 W/°F (14 W/°C)	XR29-18 Models 18 W/°F (32 W/°C)	XR47-24 Models 24 W/°F (43 W/°C)	XR47-35 Models 35 W/°F (63 W/°C)	XR60-55 Models 55 W/°F (99 W/°C)	XR60-84 Models 84 W/°F (151 W/°C)
--	--	---	---	---	---	--

3

INDUSTRY STANDARDS

UL/cUL Listed; Type 12, 3R; File No. SA7402
UR/cUR Recognized

Type 12 on XR20 and XR29-08 models
Type 3R on XR29-18 and larger models when surface mounted vertically on an enclosure
CE
GOST

APPLICATION

- Industrial automation
- Package handling equipment
- Security and defense systems
- And more

FEATURES

- Unique counterflow aluminum core for high-efficiency and high-performance heat transfer, except for the XR20 and XR29-08 which use a modified heat pipe core
- Models for 115 and 230 VAC power input
- UL Listed or Recognized to save customers time and money with agency approvals
- Operating temperature range from -20 F/-29 C to 140 F/60 C
- Streamlined aesthetics with no visible mounting rails; Slim design allows for mounting to narrow or shallow enclosures
- Reliable top-quality bearing fans and impellers make these units run quietly and with increased reliability
- Low-carbon mild-steel sheet-metal cover for rugged factory environments
- Easy-mount flanges for simple installation
- Mounting hardware, gaskets and user manual furnished with the unit
- Every unit functionally tested before shipping
- Filterless design for low maintenance and easy cleaning
- Four fasteners allow simple removal of front cover for easy access

FINISH

- RAL 7035 light-gray, semi-textured powder-coat paint standard
- Stainless steel Type 304 or 316 finishes available on Type 4X models
- Other colors and textures available

OPTIONS

- Special Voltage Package
 - Outdoor Package*
 - Harsh Environment Package*
 - Stainless Steel Package*
- * CLIMAGUARD™ may be more appropriate. Refer to CLIMAGUARD Air-to-Air Outdoor chapter. Consult the factory for availability and catalog number.

NOTES

Visit www.McLeanCoolingTech.com to download 2D and 3D CAD drawings into the overall design of your electronic system

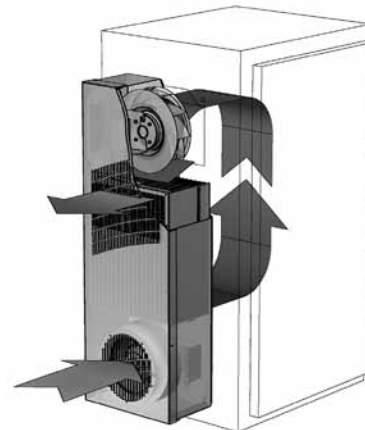

Performance Data **XR20 Models 4 W/°F (7 W/°C)**

CATALOG NUMBER		
	XR200416012	XR200426012
COOLING PERFORMANCE		
Nominal:		
W per °F	4	4
W per °C	7	7
Refrigerant	R-134A	R-134A
Refrigerant Charge (ounces/grams)	4/113	4/113
Operating Temperature Range:		
Maximum (°F/°C)	140/60	140/60
Minimum (°F/°C)	-20/-29	-20/-29
Airflow at 0 Static Pressure:		
Internal loop 50 Hz (CFM / m³/hr.)	71/121	71/121
External loop 50 Hz (CFM / m³/hr.)	75/127	75/127
Internal loop 60 Hz (CFM / m³/hr.)	74/126	74/126
External loop 60 Hz (CFM / m³/hr.)	78/132	78/132
ELECTRICAL DATA		
Rated Voltage	115	230
Frequency (Hz)	50/60	50/60
Operating Range	+/- 10%	+/- 10%
Max. Power Consumption (W at 50/60 Hz)	69	69
Max. Nominal Current (A at 50/60 Hz)	0.6	0.3
Agency Approvals	cUL Listed CE GOST	
Power Input Description	6-ft. cord with NEMA 5-15 plug	6-ft. cord with NEMA 6-15 plug
ENCLOSURE PROTECTION		
UL Type	Type 12 standard	
SOUND LEVEL		
At 1.5 Meters	56 dBA	
UNIT CONSTRUCTION		
Material	Mild steel sheet metal standard Stainless steel optional	
Finish	RAL 7035 light-gray, semi-textured powder-coat paint standard	
UNIT DIMENSIONS		
Height (in./mm)	20/508	20/508
Width (in./mm)	7.5/190.5	7.5/190.5
Depth (in./mm)	3/76.2	3/76.2
Weight (lb./kg)	12/5.4	12/5.4

Mounting Options

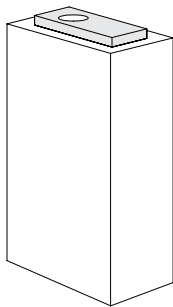

External Top-Mount

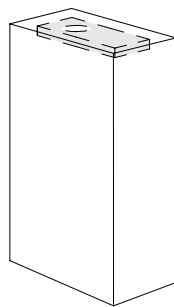

Internal Top-Mount

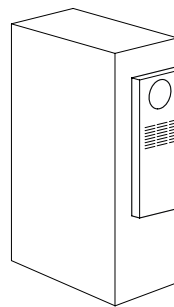

External Vertical-Mount

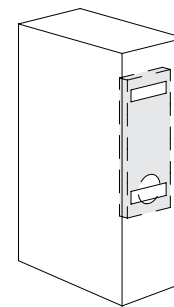

Internal Vertical-Mount

Note:
Internal mounting requires inverting the heat exchanger as shown.

87569532



Performance Data **XR29 Models 8 W/°F (14 W/°C)**

CATALOG NUMBER		
	XR290816012	XR290826012
COOLING PERFORMANCE		
Nominal:		
W per °F	8	8
W per °C	14	14
Refrigerant	R-134A	R-134A
Refrigerant Charge (ounces/grams)	5.5/156	5.5/156
Operating Temperature Range:		
Maximum (°F/°C)	140/60	140/60
Minimum (°F/°C)	-20/-29	-20/-29
Airflow at 0 Static Pressure:		
Internal loop 50 Hz (CFM / m³/hr.)	71/121	71/121
External loop 50 Hz (CFM / m³/hr.)	75/127	75/127
Internal loop 60 Hz (CFM / m³/hr.)	74/126	74/126
External loop 60 Hz (CFM / m³/hr.)	78/132	78/132
ELECTRICAL DATA		
Rated Voltage	115	230
Frequency (Hz)	50/60	50/60
Operating Range	+/- 10%	+/- 10%
Max. Power Consumption (W at 50/60 Hz)	69	69
Max. Nominal Current (A at 50/60 Hz)	0.6	0.3
Agency Approvals	cUL Listed CE GOST	
Power Input Description	6-ft. cord with NEMA 5-15 plug	6-ft. cord with NEMA 6-15 plug
ENCLOSURE PROTECTION		
UL Type	Type 12 standard	
SOUND LEVEL		
At 1.5 Meters	56 dBA	
UNIT CONSTRUCTION		
Material	Mild steel sheet metal standard Stainless steel optional	
Finish	RAL 7035 light-gray, semi-textured powder-coat paint standard	
UNIT DIMENSIONS		
Height (in./mm)	29.5/749.3	29.5/749.3
Width (in./mm)	10/254	10/254
Depth (in./mm)	3.09/78.5	3.09/78.5
Weight (lb./kg)	21/9.5	21/9.5



XR29 Models 8 W/°F (14 W/°C)

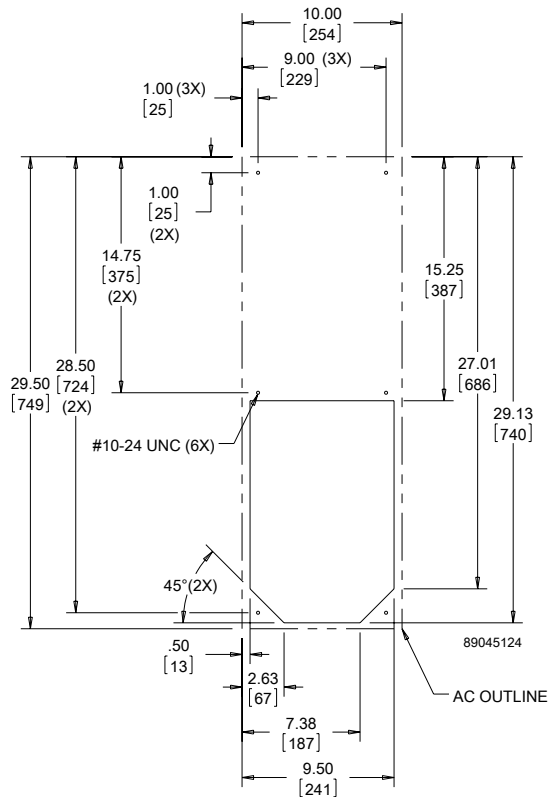
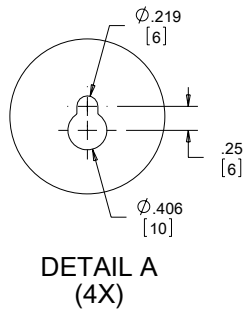
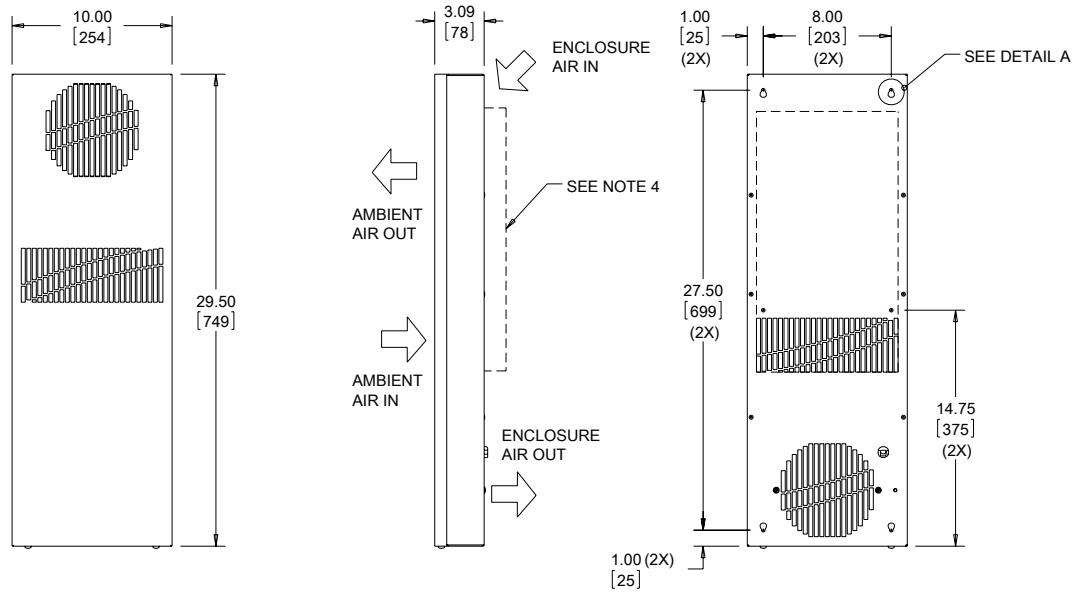

Cutout Dimensions

- NOTE:
1. MOUNTING GASKET SUPPLIED (NOT SHOWN)
 2. UNITS: in [mm]
 3. SERVICE CORD TERMINATED WITH APPROPRIATE PLUG:
NEMA 5-15P FOR 115V UNITS
NEMA 6-15P FOR 230V UNITS
 4. DETACHABLE AIRFLOW PLENUM MAY BE USED WHEN MOUNTING THE HEAT EXCHANGER INSIDE OR OUTSIDE OF THE ENCLOSURE

Visit www.McLeanCoolingTech.com to download 2D and 3D CAD drawings into the overall design of your electronic system.

Performance Data **XR29 Models 18 W/°F (32 W/°C)**

CATALOG NUMBER		
	XR291816012	XR291826012
COOLING PERFORMANCE		
Nominal:		
W per °F	18	18
W per °C	32	32
Refrigerant	N/A	N/A
Refrigerant Charge (ounces/grams)	N/A	N/A
Operating Temperature Range:		
Maximum (°F/°C)	140/60	140/60
Minimum (°F/°C)	-20/-29	-20/-29
Airflow at 0 Static Pressure:		
Internal loop 50 Hz (CFM / m³/hr.)	126/214	126/214
External loop 50 Hz (CFM / m³/hr.)	120/204	120/204
Internal loop 60 Hz (CFM / m³/hr.)	140/237	140/237
External loop 60 Hz (CFM / m³/hr.)	133/226	133/226
ELECTRICAL DATA		
Rated Voltage	115	230
Frequency (Hz)	50/60	50/60
Operating Range	+/- 10%	+/- 10%
Max. Power Consumption (W at 50/60 Hz)	207	207
Max. Nominal Current (A at 50/60 Hz)	1.8	0.9
Agency Approvals		cUL Listed CE GOST
Power Input Description	6-ft. cord with NEMA 5-15 plug	6-ft. cord with NEMA 6-15 plug
ENCLOSURE PROTECTION		
UL Type		Type 12 standard Type 3R, 4, 4X optional
SOUND LEVEL		
At 1.5 Meters		64 dBA
UNIT CONSTRUCTION		
Material		Mild steel sheet metal standard Stainless steel optional
Finish		RAL 7035 light-gray, semi-textured powder-coat paint standard
UNIT DIMENSIONS		
Height (in./mm)	29.66/753.3	29.66/753.3
Width (in./mm)	10.24/260.1	10.24/260.1
Depth (in./mm)	5.92/150.4	5.92/150.4
Weight (lb./kg)	32/15	32/15



XR29 Models 18 W/°F (32 W/°C)

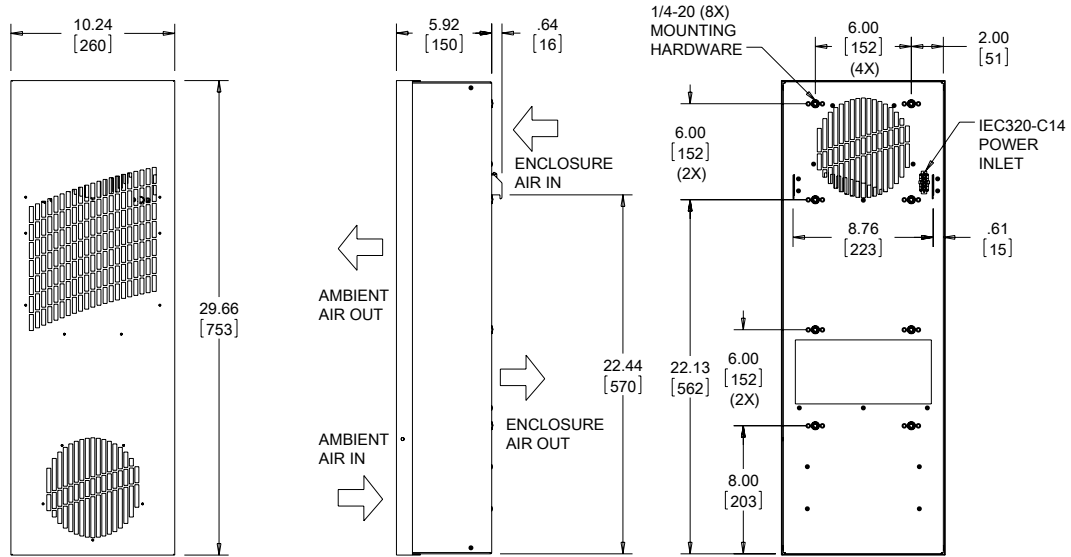

NOTE:
 1. MOUNTING GASKET SUPPLIED (NOT SHOWN)
 2. UNITS: in. [mm]

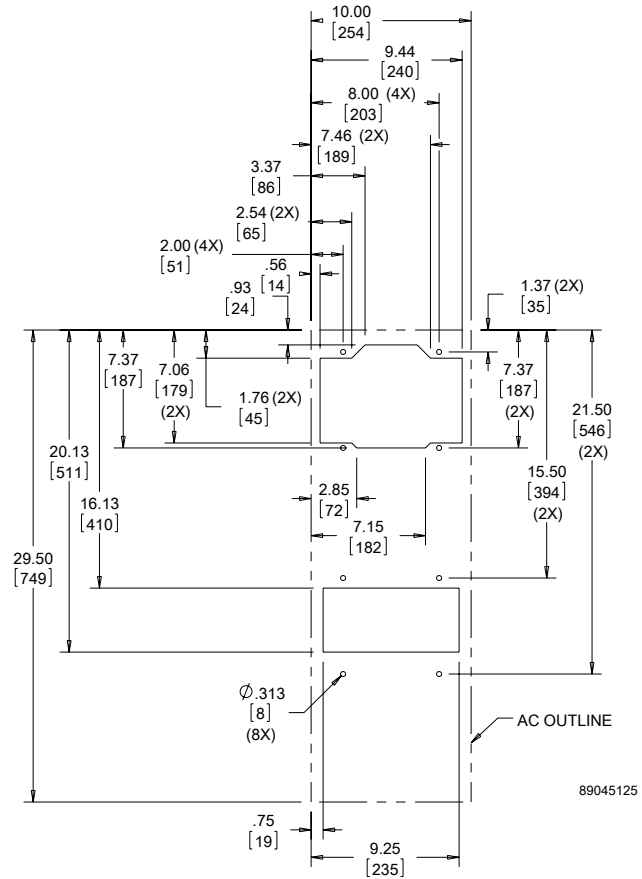

Cutout Dimensions

Visit www.McLeanCoolingTech.com to download 2D and 3D CAD drawings into the overall design of your electronic system.

Performance Data **XR47 Models 24 W/°F (43 W/°C)**

CATALOG NUMBER		
	XR472416012	XR472426012
COOLING PERFORMANCE		
Nominal:		
W per °F	24	24
W per °C	43	43
Refrigerant	N/A	N/A
Refrigerant Charge (ounces/grams)	N/A	N/A
Operating Temperature Range:		
Maximum (°F/°C)	140/60	140/60
Minimum (°F/°C)	-20/-29	-20/-29
Airflow at 0 Static Pressure:		
Internal loop 50 Hz (CFM / m³/hr.)	140/238	140/238
External loop 50 Hz (CFM / m³/hr.)	118/200	118/200
Internal loop 60 Hz (CFM / m³/hr.)	156/265	156/265
External loop 60 Hz (CFM / m³/hr.)	131/222	131/222
ELECTRICAL DATA		
Rated Voltage	115	230
Frequency (Hz)	50/60	50/60
Operating Range	+/- 10%	+/- 10%
Max. Power Consumption (W at 50/60 Hz)	207	207
Max. Nominal Current (A at 50/60 Hz)	1.8	0.9
Agency Approvals		cUL Listed CE GOST
Power Input Description	6-ft. cord with NEMA 5-15 plug	6-ft. cord with NEMA 6-15 plug
ENCLOSURE PROTECTION		
UL Type		Type 12 standard Type 3R, 4, 4X optional
SOUND LEVEL		
At 1.5 Meters		68 dBA
UNIT CONSTRUCTION		
Material		Mild steel sheet metal standard Stainless steel optional
Finish		RAL 7035 light-gray, semi-textured powder-coat paint standard
UNIT DIMENSIONS		
Height (in./mm)	47.16/1197.9	47.16/1197.9
Width (in./mm)	10.24/260.1	10.24/260.1
Depth (in./mm)	5.92/150.4	5.92/150.4
Weight (lb./kg)	51/23	51/23



XR47 Models 24 W/°F (43 W/°C)

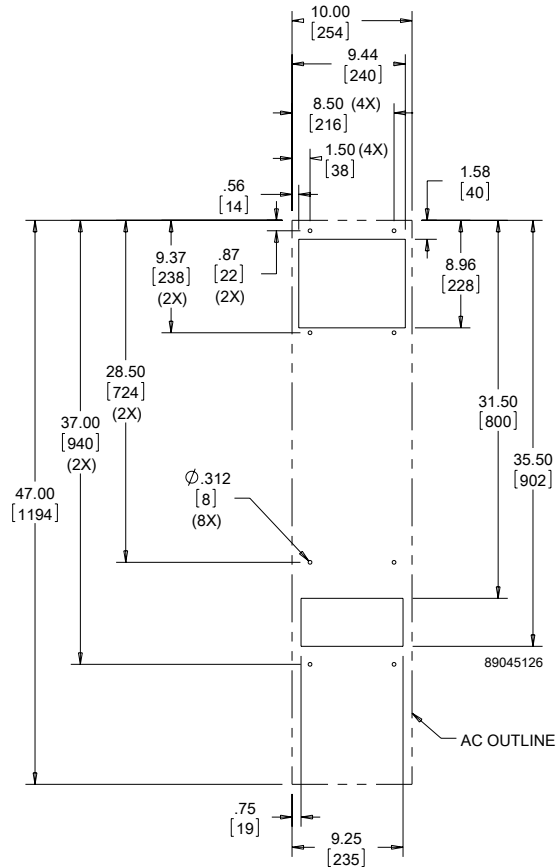
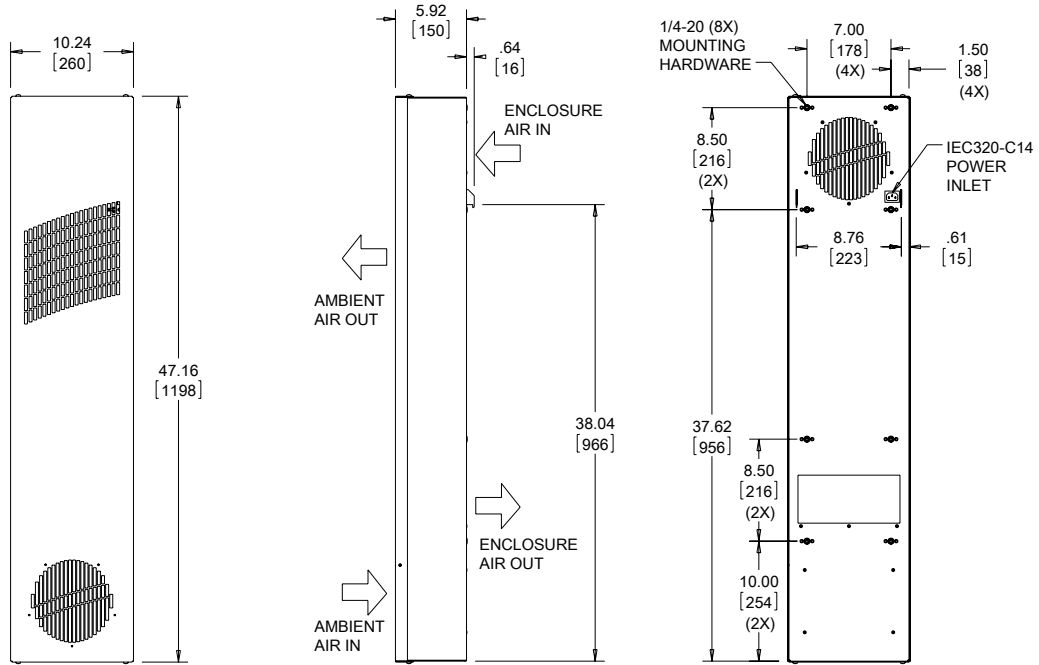

Cutout Dimensions

Visit www.McLeanCoolingTech.com to download 2D and 3D CAD drawings into the overall design of your electronic system.

Performance Data **XR47 Models 35 W/°F (63 W/°C)**

CATALOG NUMBER		
	XR473516012	XR473526012
COOLING PERFORMANCE		
Nominal:		
W per °F	35	35
W per °C	63	63
Refrigerant	N/A	N/A
Refrigerant Charge (ounces/grams)	N/A	N/A
Operating Temperature Range:		
Maximum (°F/°C)	140/60	140/60
Minimum (°F/°C)	-20/-29	-20/-29
Airflow at 0 Static Pressure:		
Internal loop 50 Hz (CFM / m³/hr.)	120/204	120/204
External loop 50 Hz (CFM / m³/hr.)	131/222	131/222
Internal loop 60 Hz (CFM / m³/hr.)	133/226	133/226
External loop 60 Hz (CFM / m³/hr.)	146/248	146/248
ELECTRICAL DATA		
Rated Voltage	115	230
Frequency (Hz)	50/60	50/60
Operating Range	+/- 10%	+/- 10%
Max. Power Consumption (W at 50/60 Hz)	207	207
Max. Nominal Current (A at 50/60 Hz)	1.8	0.9
Agency Approvals		cUL Listed CE GOST
Power Input Description	6-ft. cord with NEMA 5-15 plug	6-ft. cord with NEMA 6-15 plug
ENCLOSURE PROTECTION		
UL Type		Type 12 standard Type 3R, 4, 4X optional
SOUND LEVEL		
At 1.5 Meters		68 dBA
UNIT CONSTRUCTION		
Material		Mild steel sheet metal standard Stainless steel optional
Finish		RAL 7035 light-gray, semi-textured powder-coat paint standard
UNIT DIMENSIONS		
Height (in./mm)	47.16/1197.8	47.16/1197.8
Width (in./mm)	15.24/387.1	15.24/387.1
Depth (in./mm)	5.92/150.4	5.92/150.4
Weight (lb./kg)	59/27	59/27



XR47 Models 35 W/°F (63 W/°C)

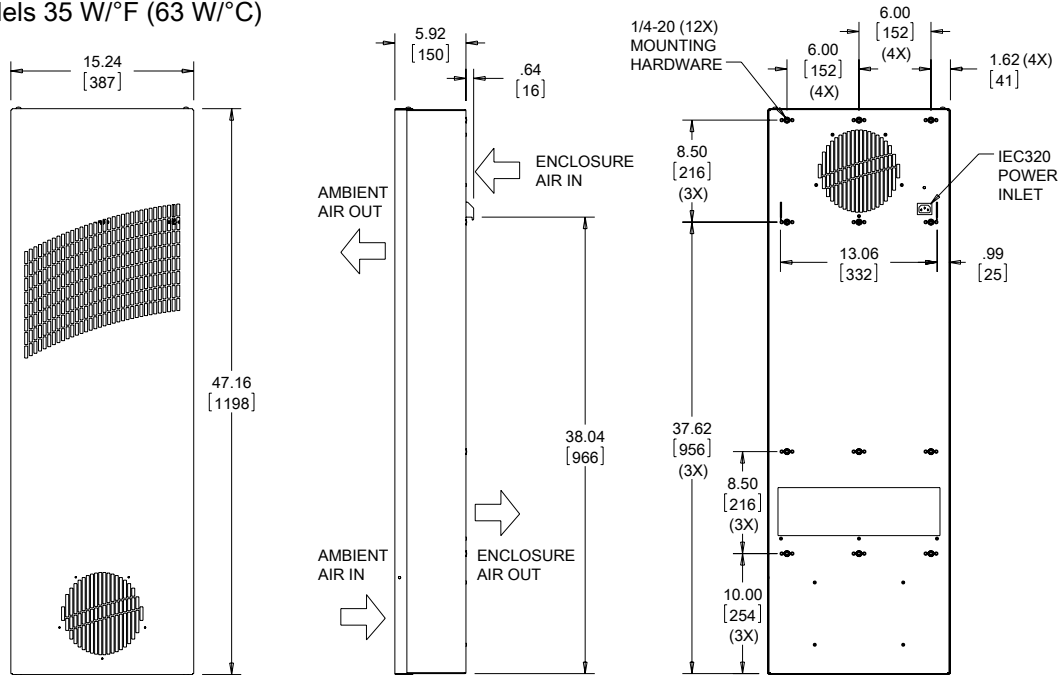

- NOTE:
1. MOUNTING GASKET SUPPLIED (NOT SHOWN)
 2. UNITS: in [mm]
 3. 2-METER LONG SERVICE CORD TERMINATED WITH APPROPRIATE PLUG:
NEMA 5-15P FOR 115V UNITS
NEMA 6-15P FOR 230V UNITS

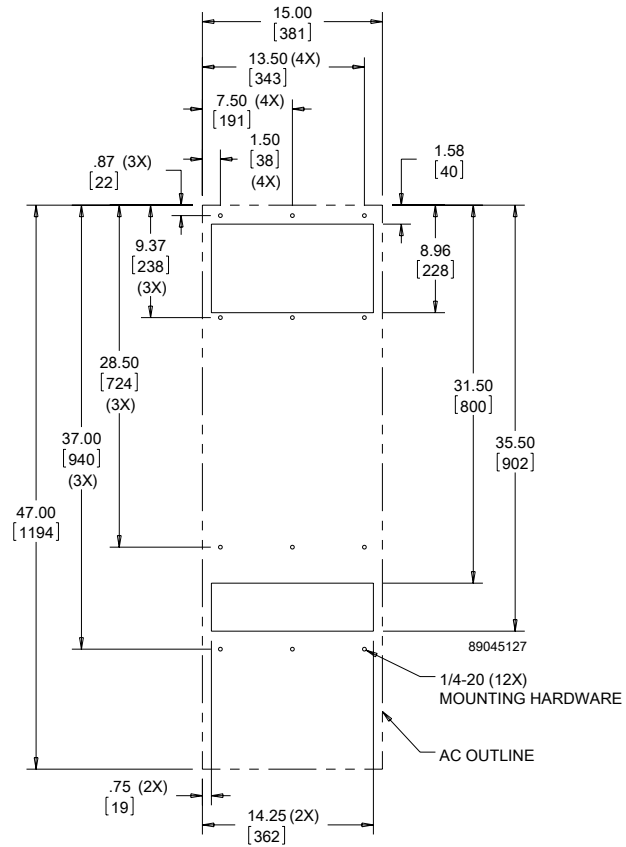

Cutout Dimensions

Visit www.McLeanCoolingTech.com to download 2D and 3D CAD drawings into the overall design of your electronic system.

Performance Data **XR60 Models 55 W/°F (99 W/°C)**

CATALOG NUMBER		
	XR605516012	XR605526012
COOLING PERFORMANCE		
Nominal:		
W per °F	55	55
W per °C	99	99
Refrigerant	N/A	N/A
Refrigerant Charge (ounces/grams)	N/A	N/A
Operating Temperature Range:		
Maximum (°F/°C)	140/60	140/60
Minimum (°F/°C)	-20/-29	-20/-29
Airflow at 0 Static Pressure:		
Internal loop 50 Hz (CFM / m³/hr.)	398/676	398/676
External loop 50 Hz (CFM / m³/hr.)	429/729	429/729
Internal loop 60 Hz (CFM / m³/hr.)	442/751	442/751
External loop 60 Hz (CFM / m³/hr.)	477/810	477/810
ELECTRICAL DATA		
Rated Voltage	115	230
Frequency (Hz)	50/60	50/60
Operating Range	+/- 10%	+/- 10%
Max. Power Consumption (W at 50/60 Hz)	759	759
Max. Nominal Current (A at 50/60 Hz)	6.6	3.3
Agency Approvals		cUL Listed CE GOST
Power Input Description	6-ft. cord with NEMA 5-15 plug	6-ft. cord with NEMA 6-15 plug
ENCLOSURE PROTECTION		
UL Type		Type 12 standard Type 3R, 4, 4X optional
SOUND LEVEL		
At 1.5 Meters		73 dBA
UNIT CONSTRUCTION		
Material		Mild steel sheet metal standard Stainless steel optional
Finish		RAL 7035 light-gray, semi-textured powder-coat paint standard
UNIT DIMENSIONS		
Height (in./mm)	59.66/1515.3	59.66/1515.3
Width (in./mm)	15.24/387.1	15.24/387.1
Depth (in./mm)	5.92/150.4	5.92/150.4
Weight (lb./kg)	86/39	86/39



XR60 Models 55 W/°F (99 W/°C)

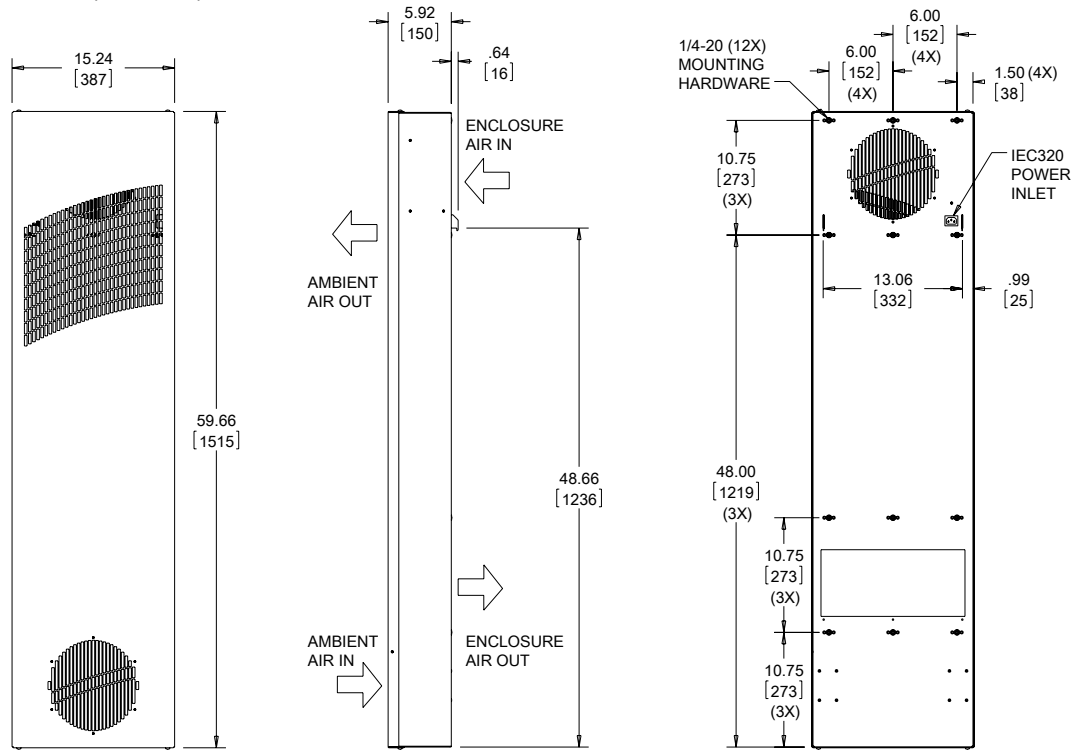

- NOTE:
1. MOUNTING GASKET SUPPLIED (NOT SHOWN)
 2. UNITS: in [mm]
 3. 2-METER LONG SERVICE CORD SUPPLIED WITH APPROPRIATE PLUG: NEMA 5-15P FOR 115V UNITS NEMA 6-15P FOR 230V UNITS

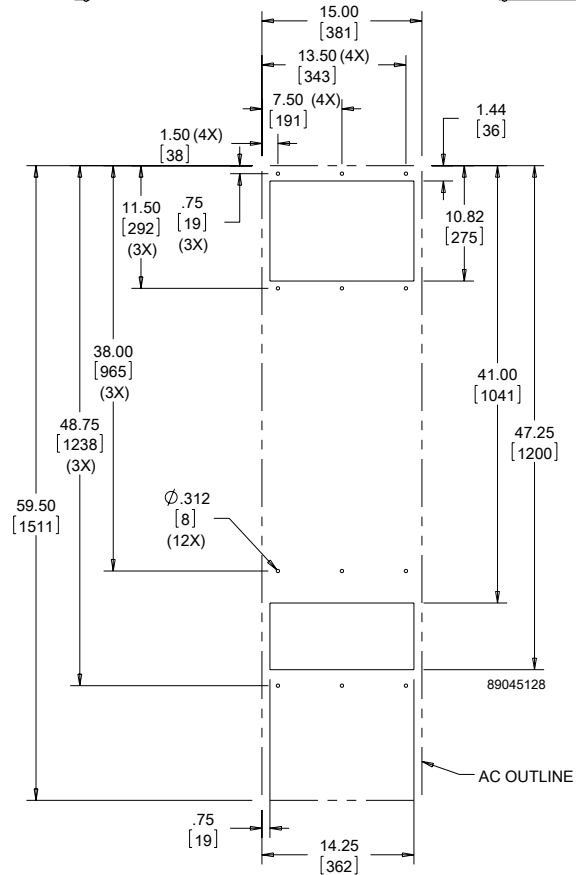

Cutout Dimensions

Visit www.McLeanCoolingTech.com to download 2D and 3D CAD drawings into the overall design of your electronic system.

Performance Data **XR60 Models 84 W/°F (151 W/°C)**

CATALOG NUMBER		
	XR608416012	XR608426012
COOLING PERFORMANCE		
Nominal:		
W per °F	84	84
W per °C	151	151
Refrigerant	N/A	N/A
Refrigerant Charge (ounces/grams)	N/A	N/A
Operating Temperature Range:		
Maximum (°F/°C)	140/60	140/60
Minimum (°F/°C)	-20/-29	-20/-29
Airflow at 0 Static Pressure:		
Internal loop 50 Hz (CFM / m³/hr.)	497/844	497/844
External loop 50 Hz (CFM / m³/hr.)	434/737	434/737
Internal loop 60 Hz (CFM / m³/hr.)	552/938	552/938
External loop 60 Hz (CFM / m³/hr.)	482/819	482/819
ELECTRICAL DATA		
Rated Voltage	115	230
Frequency (Hz)	50/60	50/60
Operating Range	+/- 10%	+/- 10%
Max. Power Consumption (W at 50/60 Hz)	759	759
Max. Nominal Current (A at 50/60 Hz)	6.6	3.3
Agency Approvals		cUL Listed CE GOST
Power Input Description	6-ft. cord with NEMA 5-15 plug	6-ft. cord with NEMA 6-15 plug
ENCLOSURE PROTECTION		
UL Type		Type 12 standard Type 3R, 4, 4X optional
SOUND LEVEL		
At 1.5 Meters		73 dBA
UNIT CONSTRUCTION		
Material		Mild steel sheet metal standard Stainless steel optional
Finish		RAL 7035 light-gray, semi-textured powder-coat paint standard
UNIT DIMENSIONS		
Height (in./mm)	59.66/1515.3	59.66/1515.3
Width (in./mm)	15.24/387.1	15.24/387.1
Depth (in./mm)	9.92/252	9.92/252
Weight (lb./kg)	106/48	106/48



